

# Aluminium Lifting Column

## MAC2

Up to 3500N

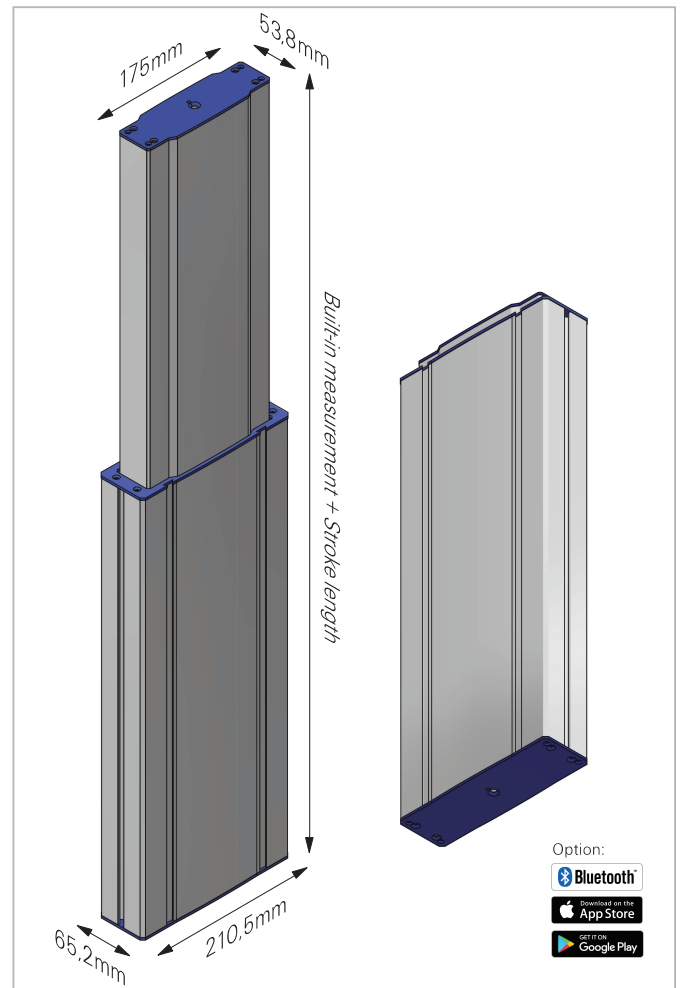

### Aluminium Lifting Column MAC2

Perfect for industrial ergonomic workplaces/benches

MAC2 is a completely new developed lifting column, designed to meet the requirements of aesthetics and quality in industrial workplaces. In the development, high stability and a reasonable price level were emphasized. The lifting column is designed for loads of max. 3500N and can be moved up to 23,5mm/s without load. The bending moment is 1000Nm.

**Plug & Play:** You can also get MAC2 as a complete Plug & Play solution, including one or more MAC2 lifting columns, a Movetec control box 230V AC, all cables and a control panel. By selecting a control box with Bluetooth®, MAC2 are easily controlled by iPhone® or Android®-Smartphone.

#### Material specifications:

Outer profile: Anodized Aluminium  
 Inner profile: Anodized Aluminium  
 Friction sliders: POM Derivate  
 Top plate: Steel  
 Bottom plate: Steel  
 Lifting drive parts: Aluminium, Steel, ABS, POM, PP

#### Technical data:

Max. load: 3500N (depends on the stroke length)  
 Max. speed without load: 23,5mm/s at 1500N (depends on force)  
 Stroke length: 100-600mm/special versions up to 1000mm (depends on force)  
 Bending moment: Dynamic 800 Nm/Static 1000 Nm (depends on the stroke length)  
 Installation length/Built-in measurement: 222-779mm  
 Operation temperature: +5° C - +45° C / Intermittens: 25%  
 Power supply/Voltage: 12/24V DC  
 Cable out: Cable out in the inner profile  
 Double Hall-sensors: Yes  
 Top plate size: 175mm x 53,8mm/43,5mm  
 Bottom plate size: 210,5mm x 65,2mm/63mm  
 Outer profile size: 210mm x 64,7mm/62,5mm  
 Inner profile size: 174,5mm x 53,7mm/43mm  
 Mounting track A: Width top 8,1mm/inside 8,1-19,9mm/depth 10,8mm  
 Mounting track B: Width top 8,8mm/bottom 13,1mm/depth 3mm  
 Control box: More options, see [www.movetec.dk](http://www.movetec.dk)  
 Synchronized drive: Max.32x/16x lifting columns in synchronized drive  
 Control panel: More options, see [www.movetec.dk](http://www.movetec.dk)  
**Options:** Bluetooth® controlling for iPhone®- and Android® Smartphones. Potentiometer. 12V DC. Top- and bottom mounting plates. Cable out in the outer profile (see MAC2U). Control box with Lithium-Ion battery pack. 100% brake. Small remote control.

# MOVETEC



True Innovative Moving Technology

# Aluminium Lifting Column

**MAC2**  
Up to 3500N

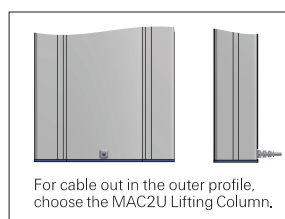

MAC2 cable out:  
Cable out in the inner profile.

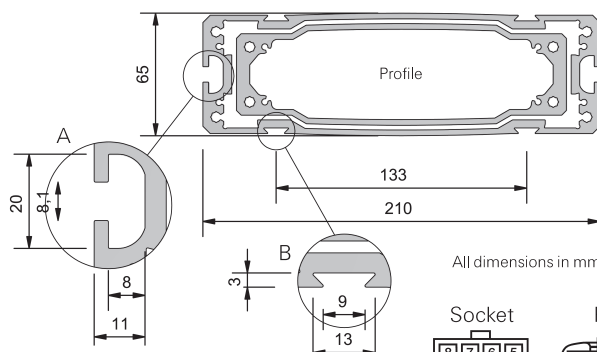
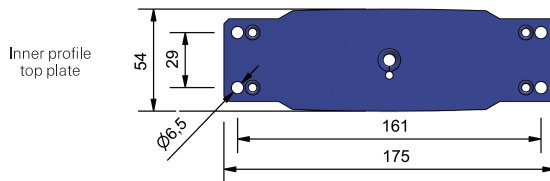
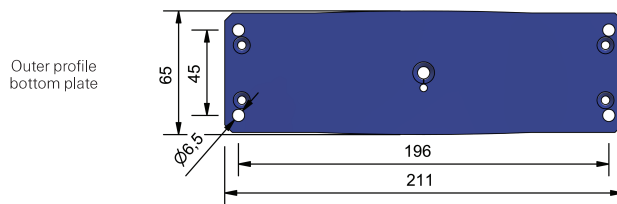
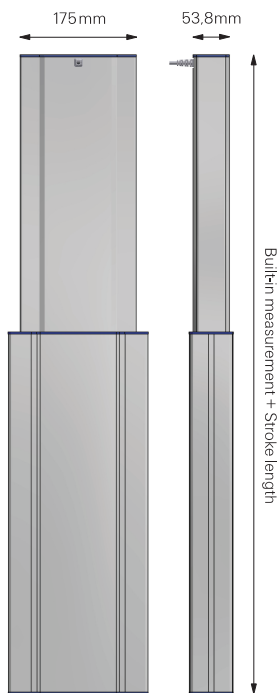
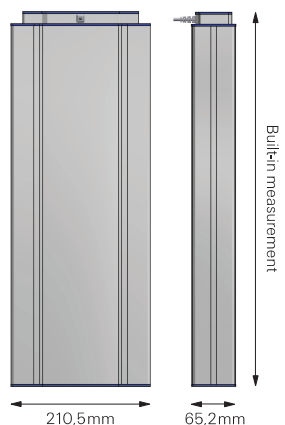

All dimensions in mm.

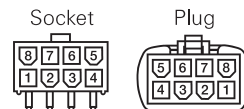

## Control boxes and control panels:

MAC2 can be used with all Movetec control boxes and Movetec control panels. Some control boxes can also be programmed for customer-specific functions - please contact us with your wishes, we are looking forward to your call: +45 64 89 28 05.

## CAD-drawings:

You can download 3D-drawings (STEP-Data) for MAC2 for your CAD-Program or as a PDF-file on our homepage.

## Lifting columns data:

Gear/drive-type no.	Load, Push N	Load, Pull N	Typ. power consumption by load A	Speed, without load (32VDC) mm/s	Stroke length in mm	Built-in measurement (by stroke length 100-600mm) in mm	Max. static bending moment Nm
G	3500	3500	4,7	12,0	100 - 600	222 - 779	1000
J	2000	2000	3,2	17,0	100 - 600	222 - 779	1000
K	1500	1500	3,5	23,5	100 - 600	222 - 779	1000
C	1500	1500	2,8	11,9	100 - 600	222 - 779	1000

## Molex plugs/connections:

Product	1	2	3	4	5	6	7	8
Color	White	Red		Green	Blue	Orange	Black	Yellow
Dual Hall	Hall 1	+5V	NC	Motor+	Hall 2	NC	Ground	Motor-

## Manuals, installation instructions, approvals/certificates, Safety instructions etc.:

Installation manuals, assembly- and installation instructions, warnings, instructional videos and further information, can be found on our homepage: [www.movetec.dk](http://www.movetec.dk)



Further information → [www.movetec.dk](http://www.movetec.dk)



Bluetooth® is a registered trademark and are the property of the owner Bluetooth SIG, Inc. Android®/ Google Play® is registered trademarks and are the property of the owner Google Inc. Apple®/ App Store® is registered trademarks and are the property of the owner Apple Inc. Other trademarks and trade names are the property of their respective owners.

© Copyright Movetec Solutions ApS. LKD/MAC2/dat014-UK/10/100/1221

# MOVETEC

Tel. +45 64 89 28 05 · [www.movetec.dk](http://www.movetec.dk)



True Innovative Moving Technology